

Multi-Gas Monitor

---

# *itx*



Instruction  
Manual

Dear Valued Customer,

Thank you for buying and using Industrial Scientific's iTX Multi-Gas Monitor.

Your iTX can be relied upon for dependable service, day after day. It has been designed, manufactured, tested and proven under the most scrutinizing conditions possible. With the minimal care and maintenance described in this Instruction Manual, it will provide you with years of reliable monitoring.

I am most concerned that you be pleased with the performance of your iTX in the months and years ahead. I urge you to call us with any questions or comments you may have. Often times a phone call and a question can save you hours of frustration. Please never hesitate to contact me at 1-800-DETECTS (338-3287).

All of us at Industrial Scientific appreciate the opportunity to serve you.

Sincerely,

A handwritten signature in black ink, appearing to read "Kent D. McElhattan". The signature is stylized and cursive, with a long horizontal line extending to the right.

Kent D. McElhattan  
President & CEO  
Industrial Scientific Corporation

# iTX

Multi-Gas  
Monitor

## TABLE OF CONTENTS

WARNINGS AND CAUTIONARY STATEMENTS .....	3
UNPACKING THE INSTRUMENT .....	6
VIEW OF INSTRUMENT .....	7
INSTRUMENT OPERATION .....	8
Turning the iTX On and Off .....	8
Gas Reading Mode .....	8
VIEWING THE iTX OPERATING MODES .....	9
PPM Explosive Gas Reading .....	9
Zeroing and Calibration .....	9
Peak Readings .....	10
STEL Readings .....	10
TWA Readings .....	10
Pause Datalog .....	10
Resetting Datalogging Session .....	11
Datalog Session .....	11
Last Calibration/Calibration Due .....	11
Time/Date/Temperature .....	12
User Identification .....	12
Site Identification .....	13
CONFIGURING THE iTX'S CUSTOM SETTINGS .....	13
Security Code .....	14
Security Features .....	14
Alarm Configuration .....	15
Sensor Calibration Gas .....	15
Quick Calibration .....	16
Zero Sensors .....	16
Zero Sensors On Startup .....	16
Allow Sensor Zeroing in the Field .....	16
Allow Calibration in the Field .....	16
Numeric Display .....	17
Peaks .....	17
Allow Viewing Peak Readings in Field .....	17
Allow Viewing STEL/TWA Reading in Field .....	17
TWA .....	17
Non-Latching .....	18
Confidence Beep .....	18
Data Logging Configuration .....	18
Allow Over-Writing of Data .....	18
Log Data On Alarm Only .....	19
Allow Manual Pause/Resume in Field .....	19
Data Logging Interval .....	19
Clear Data Logging Memory .....	19
Calibration Dates .....	19
Next Calibration Dates .....	20
Allow Viewing Calibration Dates .....	20
Current Date Screen .....	20
Allow Viewing Date and Time in Field .....	20
Backlight Shut-Off .....	21
Active User .....	21
Active Site .....	22
Allow Changing of Site and User In Field .....	22
Allow Viewing Site and User in Field .....	22
Allow Viewing Combustible PPM .....	23
CALIBRATING THE iTX .....	23
Standard Calibration .....	24
Quick Calibration .....	25
REMOTE SAMPLING .....	25
Using the iSP (Motorized Sampling Pump) .....	26
Using the Hand Aspirated Pump .....	26
MAINTENANCE .....	27-29
SPECIFICATIONS .....	29-30
EXPLODED VIEW & REPLACEMENT PARTS .....	31-33
WARRANTY .....	34
ATEX DECLARATION .....	36

# WARNINGS AND CAUTIONARY STATEMENTS

---

**Failure to perform certain procedures or note certain conditions may impair the performance of the instrument. For maximum safety and performance, please read and follow the procedures and conditions outlined below.**

- ▲ Oxygen deficient atmospheres may cause combustible gas readings to be lower than actual concentrations.
- ▲ Oxygen enriched atmospheres may cause combustible gas reading to be higher than actual concentrations.
- ▲ Verify the calibration of the combustible gas sensor after any incident where the combustible gas content has caused the instrument to latch in the OVER-RANGE alarm condition.
- ▲ Silicone compound vapors or other known contaminants may affect the combustible gas sensor and cause readings of combustible gas to be lower than actual gas concentrations. If the instrument has been used in an area where silicone vapors were present, always calibrate the instrument before next use to ensure accurate measurements.
- ▲ Sensor openings and water barriers must be kept clean. Obstruction of the sensor openings and/or contamination of the water barriers may cause readings to be lower than actual gas concentrations.
- ▲ Sudden changes in atmospheric pressure may cause temporary fluctuations in the oxygen reading.
- ▲ Recharge battery only in a non-hazardous location.
- ▲ Instrument is tested for intrinsic safety in explosive gas/air (21% oxygen) mixtures only.
- ▲ CAUTION: High Over-Range (+OR) combustible gas readings may indicate an explosive concentration of combustible gas. This condition locks the iTX in high alarm and must be manually reset by clearing the gas hazard and turning the iTX off and on again.
- ▲ iTX units equipped with bias sensors will self discharge a fully charged battery in approximately four days. Because of this, bias sensor equipped units are shipped without the battery installed. Upon receipt, install the battery and allow the bias sensors to stabilize for 24 hours. Always store bias sensor equipped iTX units on the appropriate charger (lithium-ion versions only).

# WARNINGS AND CAUTIONARY STATEMENTS

---

## **WARNING (UL CLASSIFICATION, DEMKO CERTIFICATION MSHA APPROVAL, AND CSA CERTIFICATION ONLY):**

▲ USE ONLY WITH RECHARGEABLE BATTERY PACK P/N 1708-8618 OR 4.5V ALKALINE BATTERY PACK P/N 1708-9376 CONTAINING THREE IDENTICAL ALKALINE CELLS FROM THE FOLLOWING LIST: DURACELL MN1500 OR PC 1500; EVEREADY EN91 OR LR6; GOLDPEAK 15A; PANASONIC AM-3; SEARS DIEHARD NEDA 15A; KODAK LR6; VARTA4006; OR, RAYOVAC 815. DO NOT MIX BATTERIES FROM DIFFERENT MANUFACTURERS. REPLACE ALL BATTERIES AT THE SAME TIME.

▲ THE FOLLOWING IS TO BE PERFORMED IN NON-HAZARDOUS LOCATIONS ONLY: RECHARGE LI BATTERY PACK, CHANGE LI BATTERY PACK, CHANGE ALKALINE BATTERY PACK, REPLACE ALKALINE CELLS, SERVICE UNIT OR USE COMMUNICATION PORT.

▲ DO NOT USE THE ITX IN OXYGEN ENRICHED ATMOSPHERES.

## **WARNING (MSHA APPROVAL ONLY):**

▲ P/N 1708-8618 LI-ION RECHARGEABLE PACK, THIS PACK IS NOT TO BE REPLACED BY THE USER. CHARGE IN FRESH AIR, ONLY.

## **CAUTION (UL CLASSIFICATION, MSHA APPROVAL, AND CSA CERTIFICATION ONLY):**

▲ JACK FOR USE ONLY WITH INDUSTRIAL SCIENTIFIC EXTERNAL ALARM, P/N 1810-1154 OR VIBRATING ALARM, P/N 1810-2146 ONLY.

▲ CANADIAN STANDARDS ASSOCIATION (CSA) HAS ASSESSED ONLY THE COMBUSTIBLE GAS DETECTION PORTION OF THIS INSTRUMENT FOR PERFORMANCE.

▲ CAUTION: BEFORE EACH DAY'S USAGE SENSITIVITY MUST BE TESTED ON A KNOWN CONCENTRATION OF PENTANE OR METHANE EQUIVALENT TO 25-50% OF FULL SCALE CONCENTRATION. ACCURACY MUST BE WITHIN -0-+20% OF ACTUAL. ACCURACY MAY BE CORRECTED BY REFERRING TO SECTION 5 OF THE INSTRUCTION MANUAL.

▲ CAUTION: ANY RAPID UP-SCALE READING FOLLOWED BY A DECLINING OR ERRATIC READING MAY INDICATE A GAS CONCENTRATION BEYOND UPPER SCALE LIMIT WHICH MAY BE HAZARDOUS.

# WARNINGS AND CAUTIONARY STATEMENTS

---

## ATTENTION

- ▲ LE JACK DOIT ÊTRE UTILISÉ SEULEMENT AVEC UNE ALARME EXTERNE INDUSTRIAL SCIENTIFIC N/P 1810-1154 OU UNE ALARME À VIBRATIONS N/P 1810-2146.
- ▲ L'ASSOCIATION CANADIENNE DE NORMALISATION (CSA) A ÉVALUÉ UNIQUEMENT LA PERFORMANCE DE LA PORTION DÉTECTION DE GAZ COMBUSTIBLES DE CET APPAREIL.
- ▲ READ AND FULLY UNDERSTAND THE ENTIRE INSTRUCTION MANUAL AND THIS INSTRUCTION SHEET BEFORE USING OR SERVICING THE MODEL ITX.  
S'ASSURER DE BIEN LIRE ET DE BIEN COMPRENDRE TOUTES LES INSTRUCTIONS DU MANUEL ET DE CE FEUILLET AVANT D'UTILISER ET DE PROCÉDER AU DÉPANNAGE DU MODÈLE ITX.
- ▲ OBSERVE ALL LAWS AND REGULATIONS OF THE LOCAL AUTHORITY IN REGARDS TO BATTERY DISPOSAL.
- ▲ THE MODEL ITX MULTI-GAS MONITOR (P/N 1810-4307) AND MODEL ISP SAMPLE PUMP (P/N 1810-4646) COMPLIES WITH EUROPEAN ATEX DIRECTIVE 94/9/EC AND EMC DIRECTIVE 89/336/EEC, AMENDED BY DIRECTIVES 92/31/EEC AND 93/68/EEC.
- ▲ THE MODEL ITX MULTI-GAS MONITOR (P/N 1810-4307) AND MODEL ISP SAMPLE PUMP (P/N 1810-4646) IS CONSTRUCTED WITH REFERENCE TO PUBLISHED STANDARDS OF DIRECTIVE 72/23/EEC, TO ELIMINATE ELECTRICAL RISKS AND FULFILL 1.2.7 OF ANNEX II OF DIRECTIVE 94/9/EC
- ▲ WARNING: SUBSTITUTION OF COMPONENTS MAY IMPAIR INTRINSIC SAFETY AND MAY CAUSE AN UNSAFE CONDITION!
- ▲ AVERTISSEMENT: LA SUBSTITUTION DE COMPOSANTS PEUT COMPROMETTRE LA SÉCURITÉ INTRINSÈQUE!
- ▲ PERFORMANCE CLAIMS ARE BASED UPON THE USE OF BATTERIES WHICH HAVE AN ADEQUATE CHARGE AND ADEQUATE AIR FLOW SAMPLING.
- ▲ ANY LOW BATTERY INDICATION BY THE MODEL ITX, CAUTIONS THE USER THAT THE BATTERIES INSTALLED DO NOT HAVE AN ADEQUATE CHARGE, AND THAT THE USER SHOULD REPLACE THE BATTERIES, WITH BATTERIES KNOWN TO HAVE AN ADEQUATE CHARGE, IN A NONHAZARDOUS AREA, TO AVOID THE RISK OF AN EXPLOSION.
- ▲ ANY INDICATION BY THE MODEL ISP SHOWING THAT A LOW FLOW OR BLOCKAGE CONDITION EXISTS CAUTIONS THE USER THAT THE AIR FLOW SAMPLING IS INADEQUATE AND THAT THE USER SHOULD ENSURE THAT THE MODEL ISP HAS ADEQUATE AIR FLOW SAMPLING BEFORE CONTINUING USE.
- ▲ THE MODEL ITX IS CERTIFIED FOR USE WITHIN AN AMBIENT TEMPERATURE RANGE OF -20°C TO 40°C ONLY.

# UNPACKING THE INSTRUMENT

---

The shipping box should contain the following items. Account for each item before discarding the box.

QUANTITY	PART NUMBER	DESCRIPTION
1	18104307	iTX Multi-Gas Monitor
1	17095753	iTX Instruction Manual
1	18104661	Nylon Carrying Case
1	17092339	Calibration Cup
1	17093659	Polyurethane Tubing
1	17095746	Maintenance Tool

After unpacking, if any listed item is missing, contact either your local distributor of Industrial Scientific products, or call Industrial Scientific Corporation at 1-800-DETECTS (338-3287) in the United States and Canada, or 412-788-4353.



**WARNING:** iTX units equipped with bias sensors will self discharge a fully charged battery in approximately four days. Because of this, bias sensor equipped units are shipped without the battery installed. Upon receipt, install the battery and allow the bias sensors to stabilize for 24-52 hours. Always store bias sensor equipped iTX units on the appropriate charger (lithium-ion versions only). It is not recommended to use alkaline batteries in instruments with bias sensors.

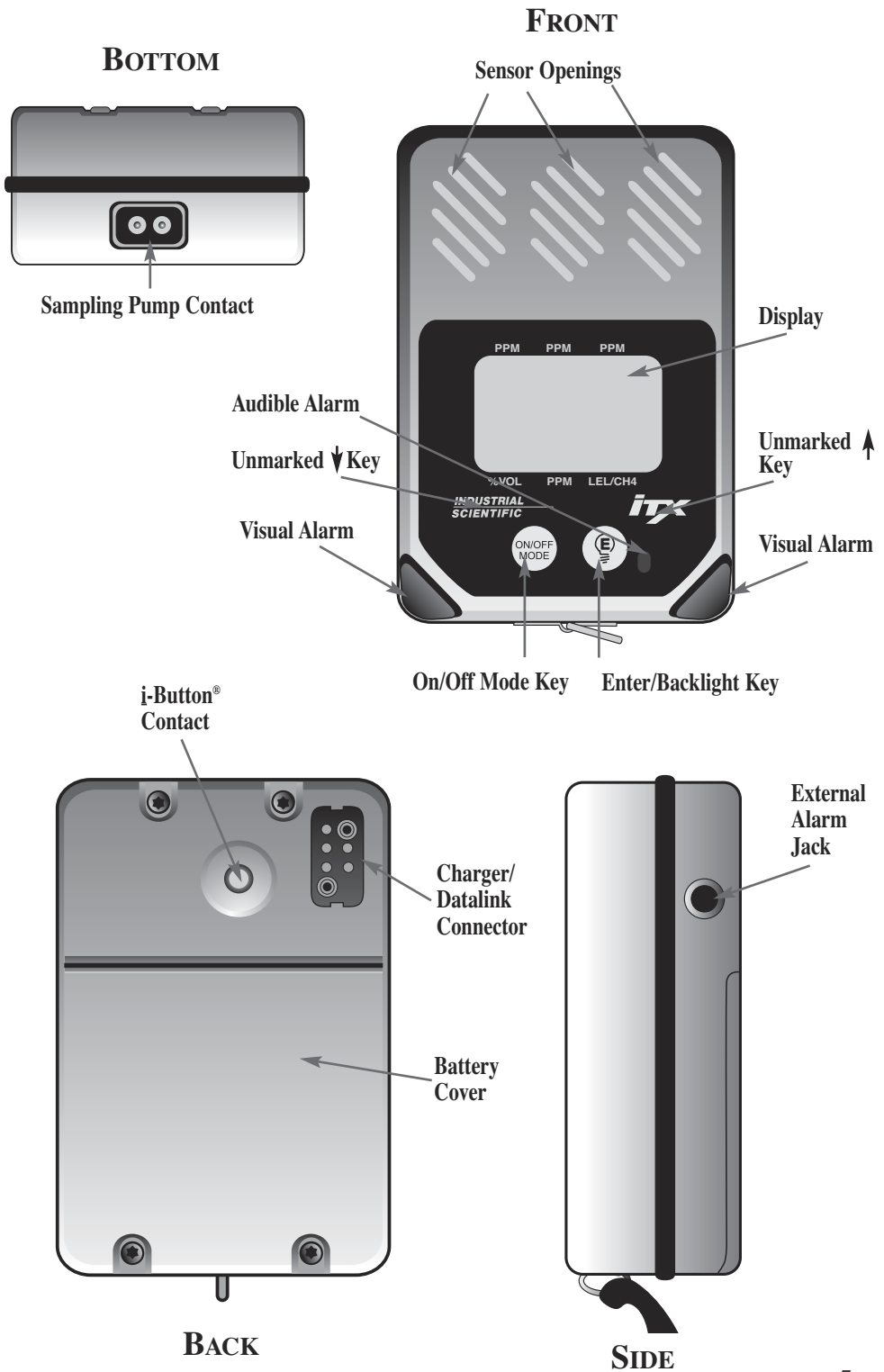



# INSTRUMENT OPERATION

---



## TURNING THE iTX ON AND OFF

---



To turn the iTX on, press and hold  until the instrument emits a short beep and the iTX welcome screen appears on the display. The current revision of instrument operating software is shown below the instrument model name.

New	CO2
Sensors	NH3
Installed	CO
	O2
	H2S
E to Continue	

After the iTX warm-up screen, the display will identify any new sensors installed which have not been calibrated in the instrument. If this screen appears, the instrument must be calibrated prior to further use. If the system clock has not been set, you will be prompted to do so.

CO	SO2	H2S
10		
O2	CL2	LEL

Prior to entering the normal operating mode, the iTX display will show the type of each sensor installed in the instrument along with a brief countdown timer until normal gas readings appear.

To turn the iTX off, press and hold  at any time during operation until the instrument display shows RELEASE. After releasing  the instrument's display will blank and all operation will cease.

## GAS READING MODE



---

CO	SO2	H2S
0	0.0	0
		
O2	Cl2	LEL
20.9	0.0	0

In the Gas Reading Mode the iTX will show the type of each sensor currently installed with the corresponding gas concentration shown directly underneath it. A battery status indicator is shown in the center of the display. As the instrument battery life is reduced, the shaded area of the battery indicator will clear until the instrument reaches the low battery condition. With 15 minutes of battery life left, a low battery condition occurs. The instrument will make a periodic tone alerting the user that the battery needs charged or replaced. If a preset gas alarm level is exceeded for either low, high, STEL or TWA, the iTX will activate audible and visual alarms and the corresponding gas display will flash.

# VIEWING THE iTX OPERATING MODES

---

During Normal Operation, pressing the  will scroll the instrument through all of the operating modes that have been enabled. While scrolling through the modes of operation, pressing the  when prompted access the desired functions. To add or remove items from the operating modes, the user must enable/disable the features through the iTX configuration settings. Accessing these custom settings is described in the Configuring iTX's Custom Section on page 11.

## PPM EXPLOSIVE GAS READING



---

If the ppm explosive feature is enabled, press  until "PPM EXP" appears. This screen will display the current concentration of explosive gas in parts per million (ppm) in 50 ppm intervals up to 10,000 ppm. If any gas reading increases to a level exceeding the low alarm set-points, the instrument will automatically return to the gas reading mode.



## ZEROING AND CALIBRATION

---

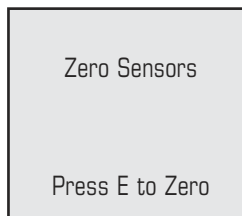

If the zero and calibrate feature is enabled, press  until "Zero Sensors" appears. Pressing  while this screen is displayed will activate the instrument's 20 second ZEROING sequence. This resets the current instrument reading and reference point to zero and calibrates the oxygen sensor to 20.9% in ambient air. After the zeroing sequence is complete, pressing  will allow you to perform a span calibration to adjust and ensure the accuracy of the instrument, see Calibrating the iTX, page 21.



## PEAK READINGS

---

CO	SO2	H2S
38	10.6	13
PEAKS		
E to Clear		
02	CL2	LEL
18.6	1.6	8

If the peak hold feature is enabled, press  until “PEAKS” appears. The peak reading displayed represents the highest toxic and explosive gas concentration and the lowest oxygen concentration measured since the peak reading was last cleared from memory. To clear and reset the peak readings, press and release  while the peak reading is displayed.

## STEL READINGS

---

CO	SO2	H2S
10	0.8	3
STEL		
CL2		
1.6		

If the iTX STEL and TWA features are enabled press  until “STEL” appears. This screen will display the current 15 minute short term exposure limit (STEL) average readings for toxic gases measured since these readings were last cleared and reset.

## TWA READINGS

---



CO	SO2	H2S
5	0.8	3
TWA		
CL2		
0.6		

If the TWA feature is enabled, pressing  once at the STEL screen will display the TWA screen. This mode displays the current time weighted average (TWA) readings of the toxic gas sensors since they were last reset. To reset STEL/TWA values, see Resetting Datalogging Session, page 8.

## PAUSE DATALOG



---

Data Logging
Paused
E To Resume

If the iTX datalogging and pause datalogging functions are enabled, press  until “Data Logging Paused” appears. The Pause/Datalog screen allows the user to temporarily stop the instrument from logging data. Datalogging may be paused or resumed by pressing  while this screen is displayed. In normal operation the video tape icon will flash while datalogging is enabled.

## RESETTING DATALOGGING SESSION

---

If the datalogging features are enabled, press  until “Start New Datalog Session” appears. Pressing  while this screen is displayed will start a new datalogging session in the instrument’s memory. Starting a new session automatically resets all STEL and TWA readings in the instrument, if they have been enabled. When a new session has begun, the session start time and date along with the data recording interval will be stamped in the instrument’s memory so that they can be retrieved at a later date.



## DATALOG SESSION

---

If the datalogging functions are enabled, press  until “Datalog Session” appears. This screen will show the elapsed time in the current datalogging session, the amount of datalogging time remaining until the instrument’s memory is full and the instrument’s current recording interval in seconds. When the memory is nearing the end of its storage capacity, care should be taken to download data to a PC, the DS1000 Docking Station, or the DS2, to ensure that critical survey data is not lost.

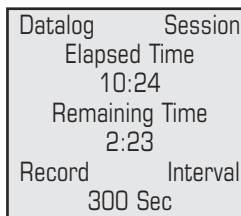

## LAST CALIBRATION/CALIBRATION DUE

---

If the last calibration and calibration date due functions are enabled press  until “Instrument Calibration Due” appears. The iTX will display the date of the last calibration or the date the instrument is next due to be calibrated based on the users choice and selected time interval. The calibration date will be automatically updated each time the instrument is calibrated (and every sensor passes) either manually or when using the DS1000 or DS2 Docking Stations.

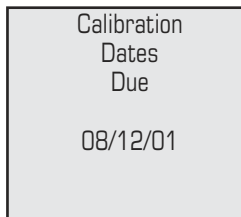

## TIME/DATE/TEMPERATURE

---

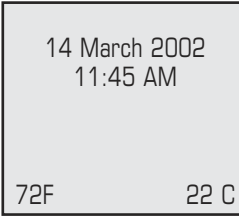



If the time/date/temperature function is enabled, press  until today's date appears. The iTX will display the current time and date along with the current temperature (inside the iTX) in degrees Fahrenheit and Celsius.



Although the current temperature reading can be a useful tool, it should not be relied upon to provide instantaneous temperature measurements. The temperature sensor will only be accurate after the instrument has had time to adjust to the environment. This typically will take several minutes and in extreme temperature conditions may take up to one-half hour.

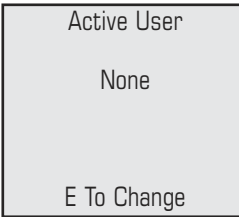



## USER IDENTIFICATION

---









Press  until "Active User" appears. This screen allows the current user's name, identification code, or number to be recorded into the instrument's datalogging memory. The user identification can be entered in one of three ways.

Pressing the  while in  mode and following the on-screen instructions will allow the current user ID to be selected.

- Pressing , allows the user to select a user name from a list previously programmed into the instrument's memory through the instrument configuration menus. Use the down arrow hidden key to scroll through the names, and the  to select the desired name.
- Pressing the up-arrow hidden key allows the user to key ID information in through the instrument keypad. Use the two hidden arrow keys to scroll through available characters, and the  to select your character. Once the desired user name is entered, press and hold the  to accept it.
- Pressing the down-arrow hidden key allows the user to enter ID information automatically with an iButton memory device. When prompted, press the  to read the iButton. After pressed, the user has 5 seconds to press their iButton onto the contact located on the back of the instrument (see page 5). After 5 seconds if no iButton is detected, the instrument will beep and let you know it failed reading the iButton. It will then go back to the Initial Active User screen.



## SITE IDENTIFICATION

Press  until “Active Site” appears. Monitoring site location codes can be entered into the instrument’s datalogging memory to correspond to measured gas concentrations in the same manner as the user identification codes. Pressing the  while in this mode and following the on screen instructions will allow the current site ID to be selected from memory

- Pressing , allows the user to select a site name from a list previously programmed into the instrument’s memory through the instrument configuration menus. Use the down arrow hidden key to scroll through the names, and the  to select the desired site name.
- Pressing the up-arrow hidden key allows the user to key ID information in through the instrument keypad. Use the two hidden arrow keys to scroll through available characters, and the  to select your character. Once the desired site name is entered, press and hold the  to accept it.
- Pressing the down-arrow hidden key allows the user to enter ID information automatically with an iButton memory device. When prompted, press the  to read the iButton. After pressed, the user has 5 seconds to press their iButton onto the contact located on the back of the instrument (see page 5). After 5 seconds if no iButton is detected, the instrument will beep and let you know it failed reading the iButton. It will then go back to the initial Active Site screen.





Active Site
None
E To Change

## CONFIGURING iTX’s CUSTOM SETTINGS

The iTX Multi-Gas monitor has many user configurable options and features. These feature may be accessed through the configuration software and a PC, the DS1000 or DS2 Docking stations, or adjusted manually by pressing the  and  hidden keys (see page 5) simultaneously during the warm-up cycle when the count down timer is displayed. Configuring your iTX is very intuitive. Every option is highlighted on the display.

CO	SO2	H2S
	10	
O2	CL2	LEL





### *In General:*

- Pressing  or  will step you through the modes or set a value.
- Pressing  selects a function or accepts (saves) a value.
- Pressing  moves you backwards in the configuration or steps you completely out of set up to the “Gas Readings Mode.”

## SECURITY CODE

---







Enter Security Code  
↑ or ↓ to Change Mode to Select Field  
E To Accept

Once the configuration mode has been entered, the instrument will prompt you to enter the 3-digit security access code if this feature has been enabled. If the security code feature is activated in the instrument no configuration changes can be made to the iTX without entering the proper security code. The security code is entered by pressing  and  to scroll through the digits from 0 to 9. Pressing  will shift the display cursor to the next digit. Once the code has been entered successfully, press  to accept the value. The iTX display will step to the next available configuration screen if the proper code has been entered.

## SECURITY FEATURES







---



Security Features  
E to Configure

If no security code has been established, the first configuration screen you will view is “Security Features.” Pressing  allows you to configure a custom code. You will then see “Change Setup Mode Security Code” prompting you to press  to change. Using the  and  keys you can set the code, use  to verify the number, and hold  to exit.

## ALARM CONFIGURATION

---

The “Alarm Configuration” mode allows you to change alarm set values for each sensor installed. Pressing the  will enter you into this menu item. All present gas sensors appear on the screen. The hidden arrow keys allow you to scroll to the different gas types. Pressing the  will select the highlighted gas sensor. Once a gas type is selected, the hidden down arrow key allows you to select which alarm type to change. Pressing the  again will select the alarm type and display the currently programmed value. Using the two hidden arrow keys, the alarm set points can be adjusted up or down. Once the desired value is met, press the  to accept it. Once accepted, you can scroll to the next alarm type you want to change, or press the  select a new gas sensor. If no more changes are required, pressing the  again will bring you to the “Save Configuration Screen”.







 saves the new alarm settings, while  aborts all changes.

Alarm  
Configuration

E to Change

## SENSOR CALIBRATION GAS

---

The “Sensor Calibration Gas” mode allows you the option of changing the concentrations of the calibration gases. To change concentrations, simply press the  to enter this mode. Once entered, the user can use the hidden down arrow key to select which calibration gas is to be changed. When the desired gas is highlighted press  to change the concentration. Using the hidden arrow keys, you can adjust the concentration up or down. Pressing  will accept the new calibration gas concentration. Once accepted, you can select the next calibration gas concentration to change. If no more changes are required, pressing the  again will bring you to the “Save Configuration Screen”.  saves the new alarm settings, while  aborts all changes.

Sensor  
Calibration  
Gas

E to Configure



## QUICK CALIBRATION

---

Quick  
Calibration

Yes

E to Change

The “Quick Calibration” mode allows you to turn this feature on or off. For details on the Quick Calibration feature, please refer to Quick Calibration, page 25.

## ZERO SENSORS

---

Zero Sensors

E to Zero

The “Zero Sensors” mode allows you to adjust the baseline of toxic and explosive gas sensors to zero and span calibrate the oxygen sensor. Once the zeroing is complete you have the option of continuing with a full span gas calibration.

Zero Sensors  
On Startup

No

E to Change

## ZERO SENSORS ON STARTUP

---

The “Zero Sensors On Startup” mode allows you to choose whether your iTX will automatically reset your toxic and explosive gas sensors to “0.0” and your oxygen reading to “20.9”. This setting should never be used if you normally power up your iTX in a contaminated environment.

Allow Sensor  
Zeroing  
in Field

No

E to Change

## ALLOW SENSOR ZEROING IN THE FIELD

---

The “Allow Sensor Zeroing in the Field” mode allows you to determine whether your iTX should be able to be zeroed in the field. By selecting “NO” the unit will not be able to be zeroed unless the function is accessed during configuration. If “YES” is selected, this mode can be entered from the “Gas Reading Mode” by pressing the 

## ALLOW CALIBRATION IN FIELD

---

Allow  
Calibration  
in Field

Yes

E to Change

The “Allow Calibration In Field” mode allows you to determine whether your iTX should be able to be span calibrated in the field. By selecting “NO” the unit will not be able to be span calibrated unless the function is accessed during configuration. If “YES” is selected, this mode can be entered from the “Gas Reading Mode” by pressing the 

## NUMERIC DISPLAY

---

The “Numeric Display” mode allows you to choose whether your iTX will display actual gas concentrations or relate the condition of the ambient air through text messages. Text readings show “OK” in non-alarm conditions and “ALARM” when an unsafe gas condition is detected. During an alarm condition, the gas/sensor that is in alarm will flash.

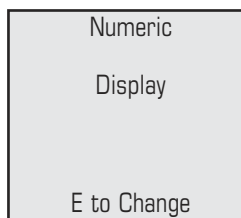

## PEAKS

---

The “Peaks” mode allows you to view or clear the highest concentration of explosive and toxic gas or the lowest concentration of oxygen since the peak readings were last cleared. Pressing  in this mode will clear all peak readings.

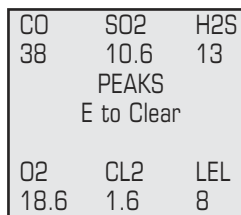

## ALLOW VIEWING PEAKS READING IN FIELD

---

The “Allow Viewing Peaks Reading In Field” mode lets you decide whether peak readings will be accessed in the field. Choosing “Yes” will display the peaks while choosing “No” blocks them from the Gas Reading Mode and can only be accessed during configuration.

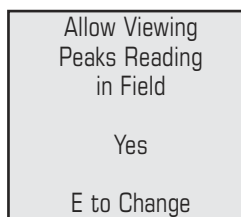

## ALLOW VIEWING STEL/TWA READING IN FIELD

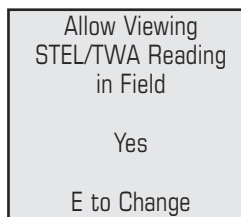

---

The “Allow Viewing STEL/TWA Reading In Field” mode lets you decide whether STEL and TWA average gas readings will be accessed in the field. Choosing “Yes” will display these average values while choosing “No” blocks them from the Gas Reading Mode.



## TWA

---

The “TWA” mode allows you to set the time duration used to calculate the Time Weighted Average gas reading. Normally this value is 8 hours, representing a normal work shift but it is adjustable from 1 to 40 hours. Press  allows you to change the time duration. Once  is pressed, the value can be adjusted by using the two hidden up/down arrow keys.



## NON-LATCHING

---

Non-Latching

Alarm  
Configuration

E to Change

The “Non-Latching Alarm Configuration” mode allows you to configure whether the iTX gas alarms will latch or not. Choosing latching alarms will cause the iTX to alarm continuously whenever a gas alarm value has been exceeded. The alarm condition will continue until the gas hazard has been cleared and the alarm has been manually reset by the user.

## CONFIDENCE BEEP

---

Confidence Beep

Yes

E to Change



The “Confidence Beep” mode allows you to control whether their iTX will sound a confidence beep once every 30 seconds. Choosing “Yes” in this mode will employ this feature while choosing “No” disables it. Confidence beep will not trigger external alarm.

## DATA LOGGING CONFIGURATION

---

Data Logging  
Configuration

E to Change

The “Data Logging Configuration” mode allows you to turn the instrument’s data logger on or off. The data logger in the iTX is designed to log 300 hours of continuous data in one minute intervals. Pressing  will grant you access to the rest of the data logging set up menus. The first prompt will ask if you if you want data logging or not. If you select “Yes” you will continue with the set-up. If you select “No” you will go back to the rest of the Configuration Mode menus. The hidden arrow keys allow you to navigate to through the data logging configuration screens. Pressing  will select that mode option and allow you to make changes.

---

### Allow Over-Writing Of Data

Allow  
Over-Writing  
Of Data

No

E to Change

The “Allow Over-Writing Of Data” mode allows you to configure whether or not the iTX’s datalogger will over-write information whenever the data logger has reached its capacity.

---

### Log Data On Alarm Only

The “Log Data On Alarm Only” mode allows you to choose whether the iTX’s datalogger will log continuously or only after the unit has gone into gas alarm. Default logging interval is one second.

Log Data On  
Alarm Only

No

E to Change

---

### Allow Manual Pause/Resume In Field

The “Allow Manual Pause/Resume In Field” mode allows you to manually pause and resume datalogging while monitoring for gases in the field.



Allow Manual  
Pause/Resume  
In Field

No

E to Change

---

### Data Logging Interval

The “Data Logging Interval” mode allows you to choose the average interval for writing data to the data logger. Once  is pressed, you can adjust the recording interval by using the two hidden arrow keys. The recording interval is adjustable from 1 second to 300 seconds. Pressing  will enter the desired interval. For example, if 60 seconds is chosen, the iTX will take a gas reading for each installed sensor once every second, average those readings over 60 seconds, and write that value to the datalogger.

Data Logging  
Interval

1 Sec

E to Change

---

### Clear Data Logging Memory

The “Clear Data Logging Memory” mode allows you to clear the data currently in memory with the touch of a key. Pressing  during this mode will clear logged data from memory.

Clear  
Data Logging  
Memory

E to Clear

---

## CALIBRATION DATES

The “Calibration Dates” mode gives you control over how you would like to have calibration date data portrayed. Choosing  to accept allows you to toggle between last calibration date and calibration date due display screens. Calibration data screens are displayed during the Gas Reading Mode.

Calibration  
Dates

Last

E to Change



Next Calibration  
Dates

30 Days

E to Change

## NEXT CALIBRATION DATES

---

The “Next Calibration Dates” mode allows you to set the frequency of calibration in terms of days. The default setting is 30 days but the value is fully adjustable. Once  is pressed, you can adjust the day interval by using the two hidden arrow keys. The days interval is adjustable from 1 to 365 days. Pressing  will enter the desired value into memory.

Allow Viewing  
Calibration  
Dates

No

E to Accept

## ALLOW VIEWING CALIBRATION DATES

---





The “Allow Viewing Calibration Dates” mode gives you control over whether the calibration dates and dates due will be accessible during the Gas Reading Mode.

14 March 2002  
11:45 AM

E to Change

## CURRENT DATE SCREEN

---

The Current Date Screen displays the date the iTX has been programmed to interpret as today’s date. Pressing  in this mode allows you to change either the date, month, year, or time of day. Using the hidden arrow keys allows you to adjust the highlighted values. Once a desired value is selected, press  to move to the next field in the date or time.  will allow you to move from field to field, while the hidden arrow keys allows you to make adjustments to the time or dates. Once everything is set, press and hold  to accept the new time and date.

Allow Viewing  
Date and Time  
in Field

No

E to Change

## ALLOW VIEWING DATE AND TIME IN FIELD

---

The “Allow Viewing Date and Time In Field” mode gives you control over whether the time and date will be accessible during the Gas Reading Mode.

## BACKLIGHT SHUT-OFF

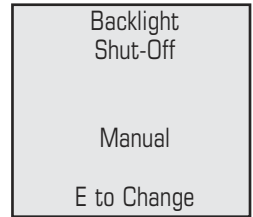

---

The “Backlight Shut-Off” mode allows you to control whether the backlight shuts off automatically or manually. Choosing “Timed” control of the backlight will automatically turn the backlight off 30 seconds after activation. Choosing “Manual” control of the backlight will leave the backlight on continuously until  is pressed.





## ACTIVE USER

---

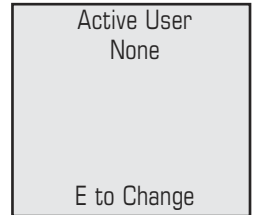
The “Active User” mode allows you to manually configure an alpha-numeric User Identification into the iTX’s datalogger. Manual entry of User IDs are not necessary when using the iButton®. Pressing  enters  into the Active User Mode. Pressing the hidden up arrow key allows the user to edit the user list, while pressing the hidden down arrow key allows the user to change the current user. If you choose to edit the user list, you can either add or delete users. Users are deleted by highlighting the desired user and pressing . Adding users to the list is accomplished two ways.





- Pressing the up-arrow hidden key allows the user to key ID information in through the instrument keypad. Use the two hidden arrow keys to scroll through available characters, and the  to select your character. Once the desired user name is entered, press and hold the  to accept it.
- Pressing the down-arrow hidden key allows the user to enter ID information automatically with an iButton memory device. When prompted, press the  to read the iButton. After pressed, the user has 5 seconds to press their iButton onto the contact located on the back of the instrument (see page 5).
- After 5 seconds if no iButton is detected, the instrument will beep and let you know it failed reading the iButton. It will then go back to the initial Active User screen.



## ACTIVE SITE

---

Active Site  
None

E to Change

The “Active Site” mode allows you to manually configure an alpha-numeric Site Identification into the iTX’s datalogger. Manual entry of Site IDs are not necessary when using the iButton®. Pressing  enters you into the Active Site Mode. Pressing the hidden up arrow key allows the user to edit the site list, while pressing the hidden down arrow key allows the user to change the current site location. If you choose to edit the site list, you can either add or delete sites. Location sites are deleted by highlighting the desired site and pressing . Adding sites to the list is accomplished two ways.

- Pressing the up-arrow hidden key allows the user to key ID information in through the instrument keypad. Use the two hidden arrow keys to scroll through available characters, and the  to select your character. Once the desired site name is entered, press and hold the  to accept it.
- Pressing the down-arrow hidden key allows the user to enter ID information automatically with an iButton memory device. When prompted, press the  to read the iButton. After pressed, the user has 5 seconds to press their iButton onto the contact located on the back of the instrument (see page 5).
- After 5 seconds if no iButton is detected, the instrument will beep and let you know it failed reading the iButton. It will then go back to the initial Active Site screen.

Allow Changing  
Site and User  
In Field

Yes

E to Change

## ALLOW CHANGING OF SITE AND USER IN FIELD

---

The “Allow Changing of Site and User In Field” mode gives you control over whether the Site and User IDs will be able to be changed in the field.

Allow Viewing  
Site and User  
In Field

No

E to Change

## ALLOW VIEWING SITE AND USER IN FIELD

---

The “Allow Viewing Site and User In Field” mode gives you control over whether the Active Site and User will be accessible during Gas Reading Mode.

## ALLOW VIEWING COMBUSTIBLE PPM

---

The “Allow Viewing Combustible PPM” mode gives you control over whether PPM levels of combustible gas will be able to be viewed from the Gas Reading Mode. If any gas reading increases to a level exceeding the low alarm set-points, the instrument will automatically return to the gas reading mode.

Allow Viewing  
Combustible  
PPM

No

E to Change

## CALIBRATING THE iTX

---

*Gas detection instruments are potential life-saving devices. Recognizing this fact, Industrial Scientific Corporation recommends that a functional (“bump”) test be performed on every instrument prior to each days use. A functional test is defined as a brief exposure of the monitor to a concentration of gas(es) in excess of the lowest alarm set-point for each sensor for the purpose of verifying sensor and alarm operation and is not intended to be a measure of the accuracy of the instrument.*



*Industrial Scientific further recommends that a full instrument calibration be performed using a certified concentration(s) of Industrial Scientific branded calibration gas(es) monthly to ensure maximum accuracy. Use of calibration gases from manufacturers other than Industrial Scientific may void product warranties and limit liability claims against the manufacturer.*

*If an instrument fails to operate properly following any functional “bump” test, a full instrument calibration should be performed prior to use.*







## STANDARD CALIBRATION

To calibrate the iTX, press  until “Zero Sensors” appears. Press  to begin the zeroing process. All toxic and combustible sensors will be reset to zero during this procedure. Once these sensors have properly zeroed, the oxygen sensor calibration screen will appear. This screen will display “O2 CAL” along with the current full span reading for the oxygen sensor. The full span value reveals how much life remains in the gas sensor.

Interpretation of the full span value will be explained at the completion of this section of this manual.

When the zeroing process is complete the instrument will beep and the “Zeroing Complete; E to Continue” screen will appear. Press  and select calibration. Select “Yes” then press  to begin the instrument span calibration. The display will show the first sensor to be calibrated along with the calibration gas concentration and the message “Apply Cal Gas.” At this point, apply the sample of a known concentration of the appropriate calibration gas at a flow rate of .5 LPM (1 SCFH) to the iTX as shown. The iTX will automatically recognize the presence of the calibration gas and display “Cal in Process” along with the current full span value of the sensor. The instrument will be calibrated automatically when the sensor response to the calibration gas becomes stable.

After each sensor has been calibrated, the instrument will beep and the display will step to the next sensor to be calibrated. The steps will be repeated automatically until each sensor has been calibrated. To skip a sensor, press  when the appropriate gas is displayed. A summary of full span values appears on the display at the completion of the calibration sequence.

Zeroing

27.8

O2 CAL

Calibrate CO  
Cal Gas = 100ppm

Apply Cal Gas

CalibratingCO

Cal in Process

Span Reserve  
112 ppm

CO	152	PASS
H2S	21	Marg

OXYG	24.7	PASS
LEL	11	Fail
E to Continue		

## QUICK CALIBRATION

---

If the Quick Cal feature of the iTX has been enabled, all sensors capable of being calibrated using a multi-component cylinder will be adjusted simultaneously. If a sensor is installed in the instrument which cannot be calibrated using the Quick Cal feature, the instrument display will automatically step to that sensor prior to starting the Quick Cal. This will save time as well as the amount of gas used during calibration and eliminate the repetition of the steps described above.

Quick Cal	
LEL	25%
O2	100 ppm
CO	100 ppm
H2S	100 ppm
Apply Cal Gas	

When the calibration process has been completed the instrument will show the calibration status display. This screen will show each sensor type along with the full span value determined during the calibration and the result of the calibration as PASS, MARGinal or FAIL. Any sensor with a full span value greater than 70% of the calibration gas value will show PASS. Full span values between 50 and 70 percent of the calibration gas value will allow the sensors to calibrate successfully but will be considered MARGinal calibrations. Marginal calibrations indicate that sensor may soon need to be replaced. Full span values less than 50% of the current calibration gas value will FAIL calibration. Sensors which fail calibration should be replaced immediately.

## REMOTE SAMPLING

---

### USING THE iSP (MOTORIZED SAMPLING PUMP)

---

By itself, the iTX is a diffusion gas monitor capable of monitoring the ambient air. When combined with the iSP motorized sampling pump, the iTX can now be used to evaluate an atmosphere up to 100 feet away.



The iSP is a parasitic sampling pump, meaning it operates without a dedicated battery and draws its power from the iTX itself. To use the iSP, simply slide it over the top end of the iTX. With the iTX turned on and the iSP fully engaged, you will hear a short audible beep and the pump motor will begin to run.

During normal operation the green LED will be illuminated signaling the pump is operating normally. At this point you may connect the probe or tubing combination (up to 100 feet) of your choice and begin remote sampling. Allow 2 seconds per sampling foot as a purge time.

Should the sampling line become obstructed, the iSP will emit an audible alarm and the red fault LED will illuminate. If this occurs, check the sample line for an obstruction or kink. Once the obstruction is removed the iSP will resume normal operation.

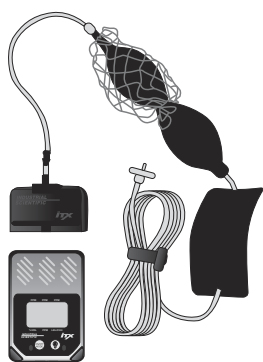

## **USING THE HAND ASPIRATED PUMP\***

---

For remote sampling applications of 10 feet or less, you may choose the hand aspirated sampling pump. Before use, inspect the hand aspirator to ensure it has not been damaged.

To use, simply slide the calibration cup over the sensor end of the iTX, making sure to provide a good seal. Purge the netted reservoir of its contents by completely compressing it. Squeeze the aspirator bulb 10 full consecutive compressions. Verify that each compression inflates the netted reservoir bulb. Proper sampling is obtained when the netted reservoir provides 40 to 80 seconds of constant flow to the calibration cup.

\* *Not a CSA approved accessory.*

# MAINTENANCE

---

With normal routine maintenance the iTX can be relied upon to provide years of reliable service. The following guidelines should be followed when performing maintenance on the iTX.

## CLEANING

---

When necessary, wipe the outside of the instrument with a soft, clean cloth. Never use solvents or cleaning solutions of any type. Make sure the sensor diffusion membrane is free of debris. Clean sensor openings with a soft, clean cloth or soft brush.

## CHARGING THE BATTERIES

---

The lithium-ion battery pack should be fully charged before using the iTX. To charge the battery pack, plug the flying lead from the iTX battery charger into the socket on the back of the instrument. The iTX battery pack will be fully charged within 5 hours. With a fully charged lithium-ion battery pack the iTX should typically function for up to 19 hours (10 hours with iSP sampling pump) of continuous operation. As the battery life decreases, the shaded area of the battery icon in the center of the display will also decrease. With a minimum of 15 minutes of battery life remaining the unit will emit a periodic tone alerting you to charge/replace the battery.

A replaceable cell alkaline battery pack is also available for use with the iTX. To remove the battery pack and replace the 3 AA battery cells loosen the two screws from the battery cover on the back of the instrument. Remove the battery pack and replace the AA battery cells with fresh alkaline batteries. Replace the battery pack and battery cover in the same fashion.



## CHANGING GAS SENSORS

---

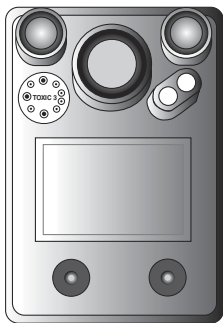

iTX sensors are designed to be changed and replaced by the user in the field without the need for factory service. To replace a sensor in the iTX remove the battery from the instrument as described above. Remove the three screws that hold the instrument case top in place and remove the case top. Be careful not to tear the cable that connects the keypad to the display board. Grasp the sensor firmly and remove from the instrument. Plug the new sensor into the open sensor port and press firmly into place. Some toxic gas sensors are shipped with a shorting wire in place on the bottom of the sensor identification board. This shorting wire must be removed prior to installing the sensor in the instrument in order for the sensor to function properly. Once the sensor has been installed, replace the instrument case top and battery pack. New sensors installed in the instrument will be recognized automatically. If a new sensor type was installed in the instrument, the display will prompt the user to calibrate the instrument before further use. After installing any of the bias sensors (NH<sub>3</sub>, NO, HCl), you must turn on the instrument so the iTX identifies that a bias sensor is installed and recognizes the need to supply a bias voltage. Then turn off the unit and put it on charge for 24 to 48 hours to allow the sensor to stabilize before calibration. The iTX should be calibrated prior to use to ensure accuracy after a sensor has been changed in the unit.

## TOXIC SENSOR CROSS SENSITIVITY CHART

---

Industrial Scientific has designed the iTX to respond as specifically as possible to the target toxic gas. Realistically, total specificity cannot be achieved in all cases. The following chart demonstrates typical cross sensitivity responses for a given sensor when exposed to a different gas.

# iTX SENSOR CROSS INTERFERENCE TABLE

Sensor	CO	H <sub>2</sub> S	SO <sub>2</sub>	NO <sub>2</sub>	Cl <sub>2</sub>	ClO <sub>2</sub>	HCN	HCl	PH <sub>3</sub>	NO	H <sub>2</sub>
Gas											
CO	100	2	1	-5	0	0	0	1000	0	0	1
H <sub>2</sub> S	10	100	1	-8	-3	0	400	25	3	35	20
SO <sub>2</sub>	0	10	100	0	0	0		0		0	0
NO <sub>2</sub>	-20	-20	-100	100	12		-12			30	0
Cl <sub>2</sub>	-10	-20	-35	-100	100	0	-20	20	-10	0	0
ClO <sub>2</sub>					20	100					
HCN	15	50	50	1	0	0	100	5	1	0	30
HCl	3	0	0	0	2	0	0	100	0	15	0
PH <sub>3</sub>						100	0	300	100		
NO	10	1	1	0						100	30
H <sub>2</sub>	60	0.05	0.5	0	0	0	0	0	0	0	100

The table above reflects the percentage response provided by the sensor listed across the top of the chart when exposed to a known concentration of the target gas listed in the left hand column.

## SPECIFICATIONS

**SIZE:** 4.75" x 3.19" x 1.68" (121mm x 81mm x 43mm)

**WEIGHT:** 18.5oz (with Li-ion battery pack)  
524.5 grams (with Li-ion battery pack)

**DISPLAY:** 128 X 64 Graphic Dot-Matrix LCD with backlighting for low light conditions. Display protected by clear lens. RFI/EMI shielding screen mounted over display area.

**RUN TIME:** Run times are specified under the following conditions: A fully charged Li-ion pack / new alkaline pack; all sensors installed; room temperature; and no alarms activated.

Alkaline batteries, without parasitic pump 12hr

Alkaline batteries, with parasitic pump 6hr

Lithium-ion battery, without parasitic pump 24hr

Lithium-ion battery, with parasitic pump 15hr

## MEASURING RANGES & RESOLUTION:

	Range	Resolution
CO	999 ppm	1 ppm
H <sub>2</sub> S	499 ppm	1 ppm
NO <sub>2</sub>	99.9 ppm	0.1 ppm
SO <sub>2</sub>	99.9 ppm	0.1 ppm
O <sub>2</sub>	30.0 %	0.1 %
Cl <sub>2</sub>	50.0 ppm	0.1 ppm
NO*	499 ppm	1 ppm
NH <sub>3</sub> *	200 ppm	1 ppm
HCN	30.0 ppm	0.1 ppm
HCl*	30.0 ppm	0.1 ppm
PH <sub>3</sub>	1.00 ppm	0.01 ppm
H <sub>2</sub>	999 ppm	1 ppm
O <sub>3</sub>	1.00 ppm	0.01 ppm
ClO <sub>2</sub>	1.00 ppm	0.01 ppm
Comb (%LEL)	100%LEL	1% LEL
Comb (%vol)	5.0% Vol	0.1% Vol
Comb (ppm)	10,000 ppm	50 ppm

\* *bias sensor*

## TEMPERATURE AND HUMIDITY RANGE:

Operating Temperature Range:

-20° to +50° C (-4° to 122° F), typical toxic/oxygen  
0° to +40° C (32° to 104° F), for LEL sensor only  
per C22.2 No. 152

Operating Humidity Range:

15 – 95% RH, typical  
0 – 99% RH, intermittent, non-condensing

Storage Temperature Range:

0° to +20° C (32° to 68° F)

# REPLACEMENT PARTS LIST

---

ITEM.	PART NO.	DESCRIPTION
1.	17102484	iTX Main PCB Version 2.X (17088667 for Version 1.X)
2.	17105255	iTX Sensor PCB Version 2.X (17090473 for Version 1.X)
3.	17102526	iTX Interface PCB Version 2.X (17090481 for Version 1.X)
5.	17104266	iTX Keypad Version 2.X (17091307 for Version 1.X)
6.	17096389	iTX Case top assembly
7.	17096082	iTX Case bottom
8.	17091083	iTX Case gasket
10	17098450	iTX Battery cover assembly
11	17091901	Battery cover gasket
12	17092651	Battery insulator
13.	17092693	Screw retainer
14	17095332	Battery cover screws
18	17092198	iTX Chassis
19	17091620	Pump contact module
20	17091869	Pump contact gasket
21	17091588	Pump contact clip
22	17096371	iTX Water barrier kit
27	17092685	Screw, captive, #4x1.125
28	17086935	Screw, 2-56 x 0.31
29	17050453	Screw, 2-56x .188
30	17052558	Screw, 2-28 x .250
32	17049876	Wrist strap
35	17092776	RFI screen
36	17092750	Conductive adhesive
37	17084542	LCD holder
38	17084673	LCDisplay
39	17092743	Insulator pad
40	17099860	i-Button® insulator
41	17028374	External alarm jack
42	17029273	Alarm jack plug
43	17050277	O-ring .250 ID



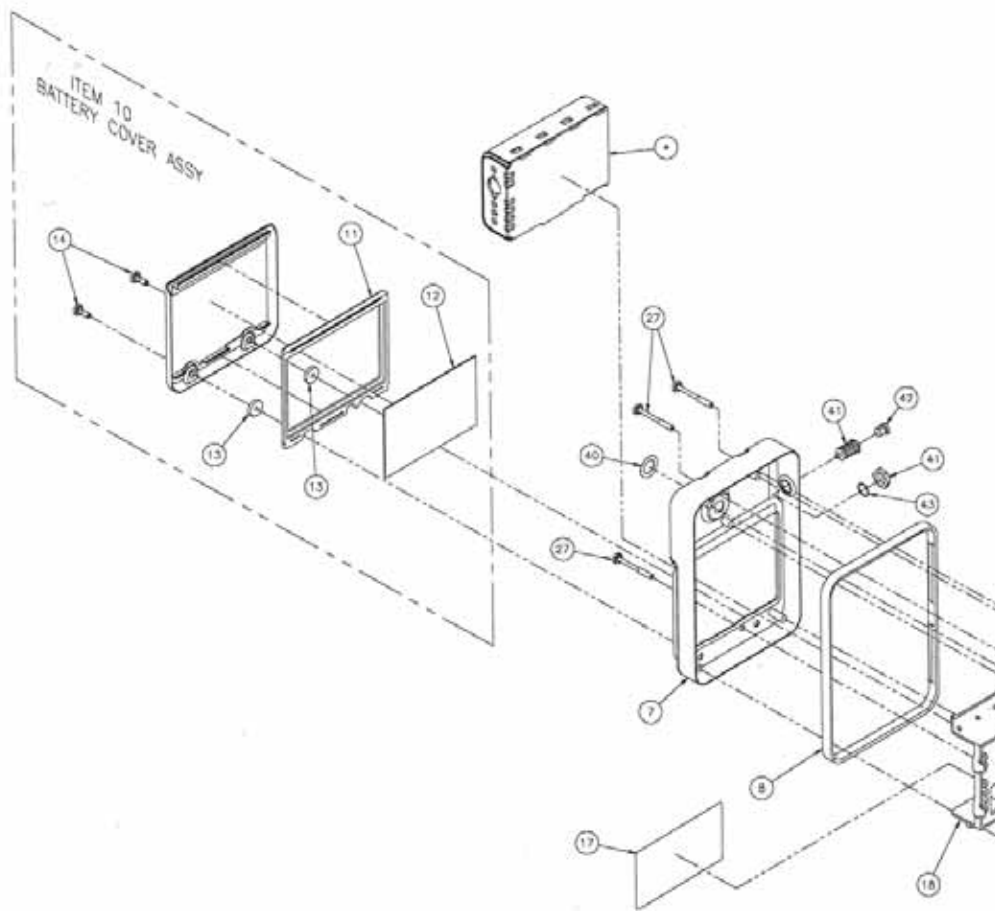

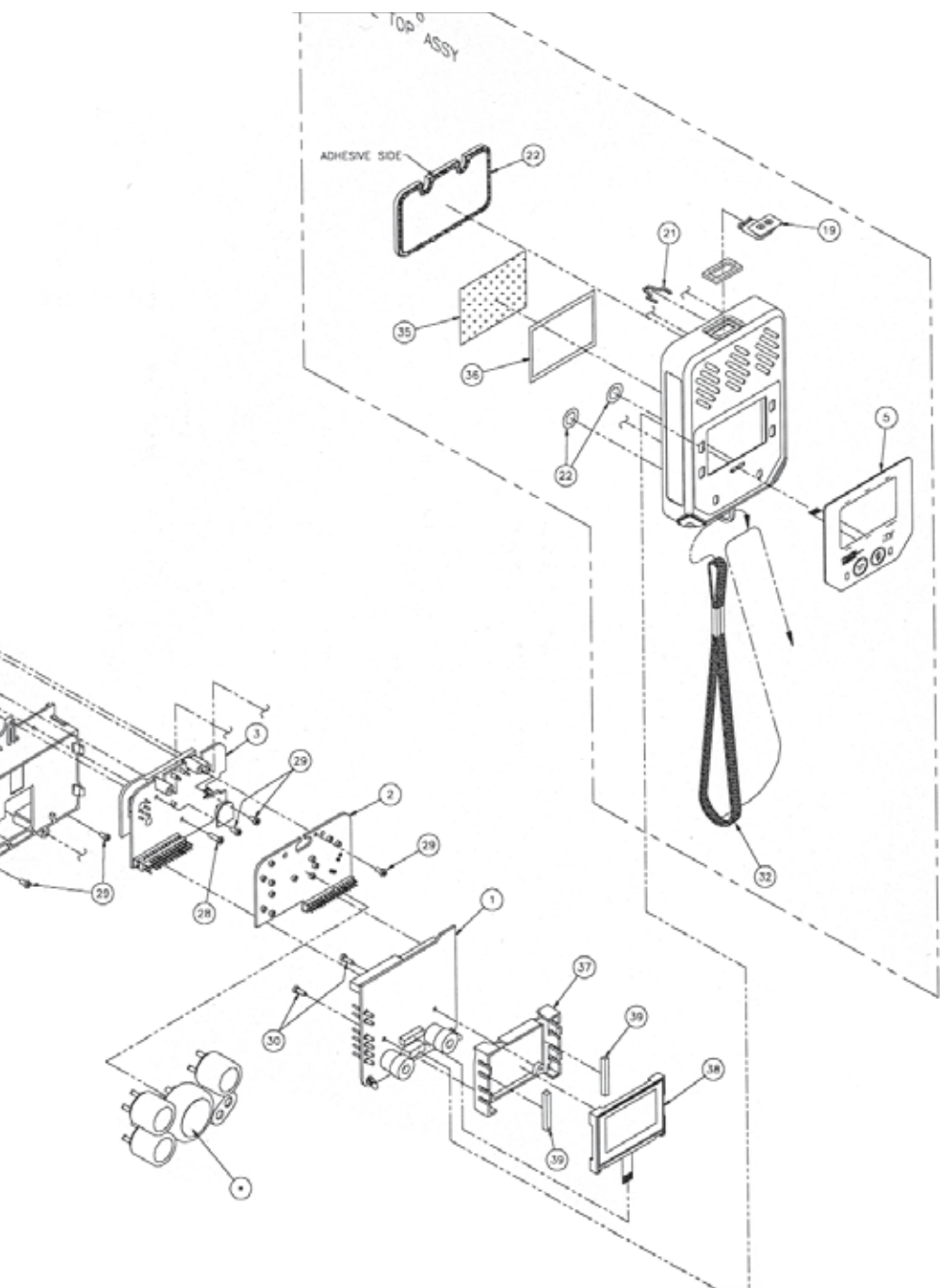

# WARRANTY

---

Industrial Scientific Corporation portable gas monitoring instruments are warranted to be free from defects in material and workmanship for as long as the instrument is in service.

The above warranty does not include sensors, battery packs, internal pumps or filters, all of which are warranted to be free from defects in material and workmanship for 18 months from the date of shipment, or 1 year from the date of first use, whichever occurs first, except where otherwise stated in writing in Industrial Scientific literature accompanying the product.

All other Industrial Scientific products are warranted to be free from defects in material and workmanship for a period of 18 months from the date of shipment, 1 year from the date of first use, whichever occurs first, except where otherwise stated in writing in Industrial Scientific literature accompanying the product.

## LIMITATION OF LIABILITY

INDUSTRIAL SCIENTIFIC MAKES NO OTHER WARRANTIES, EITHER EXPRESSED OR IMPLIED, INCLUDING BUT NOT LIMITED TO THE WARRANTIES OF MERCHANTABILITY OR FITNESS FOR PARTICULAR PURPOSE.

SHOULD THE PRODUCT FAIL TO CONFORM TO THE ABOVE WARRANTY, BUYER'S ONLY REMEDY AND INDUSTRIAL SCIENTIFIC'S ONLY OBLIGATION SHALL BE, AT INDUSTRIAL SCIENTIFIC'S SOLE OPTION, REPLACEMENT OR REPAIR OF SUCH NON-CONFORMING GOODS OR REFUND OF THE ORIGINAL PURCHASE PRICE OF THE NON-CONFORMING GOODS.

IN NO EVENT WILL INDUSTRIAL SCIENTIFIC BE LIABLE FOR ANY OTHER SPECIAL, INCIDENTAL OR CONSEQUENTIAL DAMAGES, INCLUDING LOSS OF PROFIT OR LOSS OF USE, ARISING OUT OF THE SALE, MANUFACTURE OR USE OF ANY PRODUCTS SOLD HEREUNDER WHETHER SUCH CLAIM IS PLEADED IN CONTRACT OR IN TORT, INCLUDING STRICT LIABILITY IN TORT.

It shall be an express condition to Industrial Scientific's warranty that all products be carefully inspected for damage by Buyer upon receipt, be properly calibrated for Buyer's particular use, and be used, repaired, and maintained in strict accordance with the instructions set forth in Industrial Scientific's product literature. Repair or maintenance by non-qualified personnel will invalidate the warranty, as will the use of non-approved consumables or spare parts. As with any other sophisticated product, it is essential and a condition of Industrial Scientific's warranty that all personnel using the products be fully acquainted with their use, capabilities and limitations as set forth in the applicable product literature.

Buyer acknowledges that it alone has determined the intended purpose and suitability of the goods purchased. It is expressly agreed by the parties that any technical or other advice given by Industrial Scientific with respect to the use of the goods or services is given without charge and at Buyer's risk; therefore, Industrial Scientific assumes no obligations or liability for the advice given or results obtained.

## **Copyright**

2003 © Industrial Scientific Corporation

All rights reserved. These help materials or any part thereof may not, without the written consent of Industrial Scientific Corporation, be copied, reprinted or reproduced in any material form including but not limited to photocopying, transcribing, transmitting or storing it in any medium or translating it into any language, in any form or by any means, be it digitally, electronic, mechanical, xerographic, optical, magnetic or otherwise.

The information contained in this document is proprietary and confidential and all copyright, trade marks, trade names, patents and other intellectual property rights in the documentation are the exclusive property of Industrial Scientific Corporation unless otherwise specified. The information (including but not limited to data, drawings, specification, documentation, software listings, source or object code) shall not at any time be disclosed directly or indirectly to any third party without prior written consent.

The information contained herein is believed to be accurate and reliable. Industrial Scientific Corporation accepts no responsibility for its use by any means or in any way whatsoever. Industrial Scientific Corporation shall not be liable for any expenses, costs by damage that may result from the use of the information contained within this document. The information contained herein is subject to change without notice.

**CORPORATION**1001 Oakdale Road  
Oakdale, PA 15071-1500  
USAPhone: 412-788-4353  
1-800-DETECTS (338-3287)  
Fax: 412-788-8353  
[www.indsci.com](http://www.indsci.com)

# EC Declaration of Conformity

Manufacturer:  
Manufacturer's Address:Industrial Scientific Corporation  
1001 Oakdale Road  
Oakdale, Pennsylvania 15071  
United States of AmericaLocal Representative's Name:  
Local Representative's Address:Industrial Scientific Corporation  
Speelhuyslaan 173  
4814 CD Breda  
The NetherlandsType of Equipment:  
Model:Multi-Gas Monitor with optional Sample Pump  
iTX Multi-Gas Monitor (P/N 1810-4307)  
iSP Sample Pump (P/N 1810-4646)

**DESCRIPTION:** The iTX Multi-Gas Monitor is a hand held portable device capable of monitoring and recording data for combustible, oxygen and up to four toxic gases or vapors simultaneously. It is equipped with audio and visual alarms; preset and user defined. Recorded data can be downloaded for analysis and storage. The iSP Sample Pump is powered from the iTX and can be used to sample gases from remote locations.

**DECLARATION:** Industrial Scientific Corporation declares that the iTX Multi-Gas Monitor and iSP Sample Pump conforms to all of the relevant provisions of the EC Council ATEX Directive 94/9/EC dated 23 March 1994.

Quality Assurance Notification:  
Issued by Notified Body:SIRA 00 ATEX M080  
SIRA Certification Services (0518)EC-Type-Examination Certificate:  
Issued by Notified Body:02 ATEX 0147176X  
UL International DEMKO A/S (0539)  
LYSKAER 8, P.O. Box 514  
DK -- 2730, HERLEV, DENMARK

Standards:

EN 50014:1997+A1:1999,+A2:1999, EN 50020:1994  
EN 50018:1998, EN 60529:1991

Declarations to other relevant EC Community Directives: EMC: 89/336/EEC, 92/31/EEC &amp; 93/68/EEC

Standards:

EN 50270:1999

I, the undersigned, as authorized representative of Industrial Scientific Corp., declare that the equipment specified above conforms to the above Directive(s) and Standard(s).

Place: Oakdale, PASignature: Date: July 1, 2003David D. Wagner  
Product Manager

OUR MISSION  
Design-Manufacture-Sell: Highest quality products for the preservation of life and property  
Provide: Best customer service available

P/N 1709-5753  
Rev 6  
Printed 0709-1000  
Specifications Subject to Change

**GUARANTEED.**  
**FOR LIFE.**



1001 Oakdale Road, Oakdale, PA 15071-1500  
(412) 788-4353 • Toll Free 1-800-DETECTS  
FAX 412-788-8353 • Service Dept. 1-888-788-4353

**INDUSTRIAL SCIENTIFIC**  

---

**CORPORATION**