

Farmington 2012

Safety and Training

It's Worth it!



Problem 2

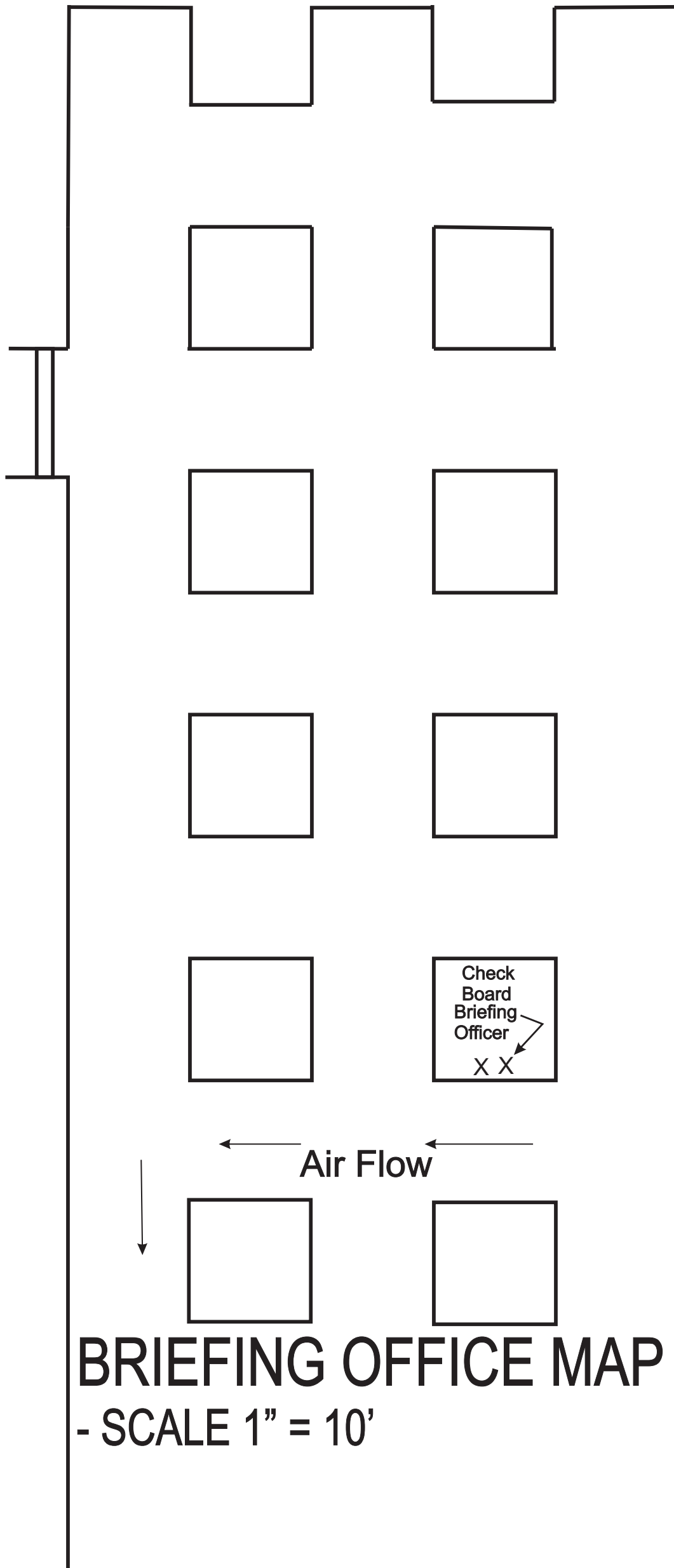

BRIEFING OFFICE MAP
- SCALE 1" = 10'

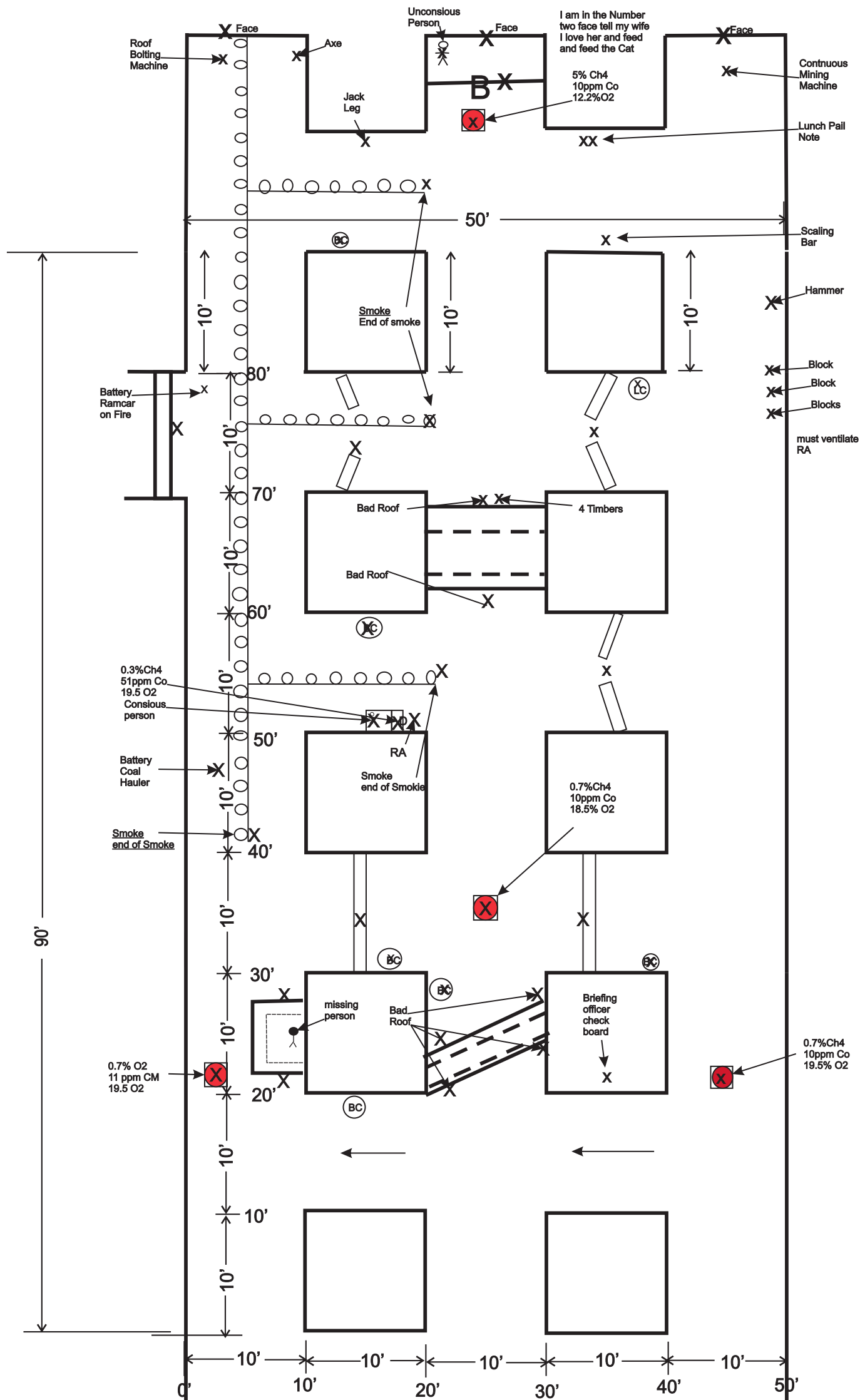

FIELD LAYOUT MAP

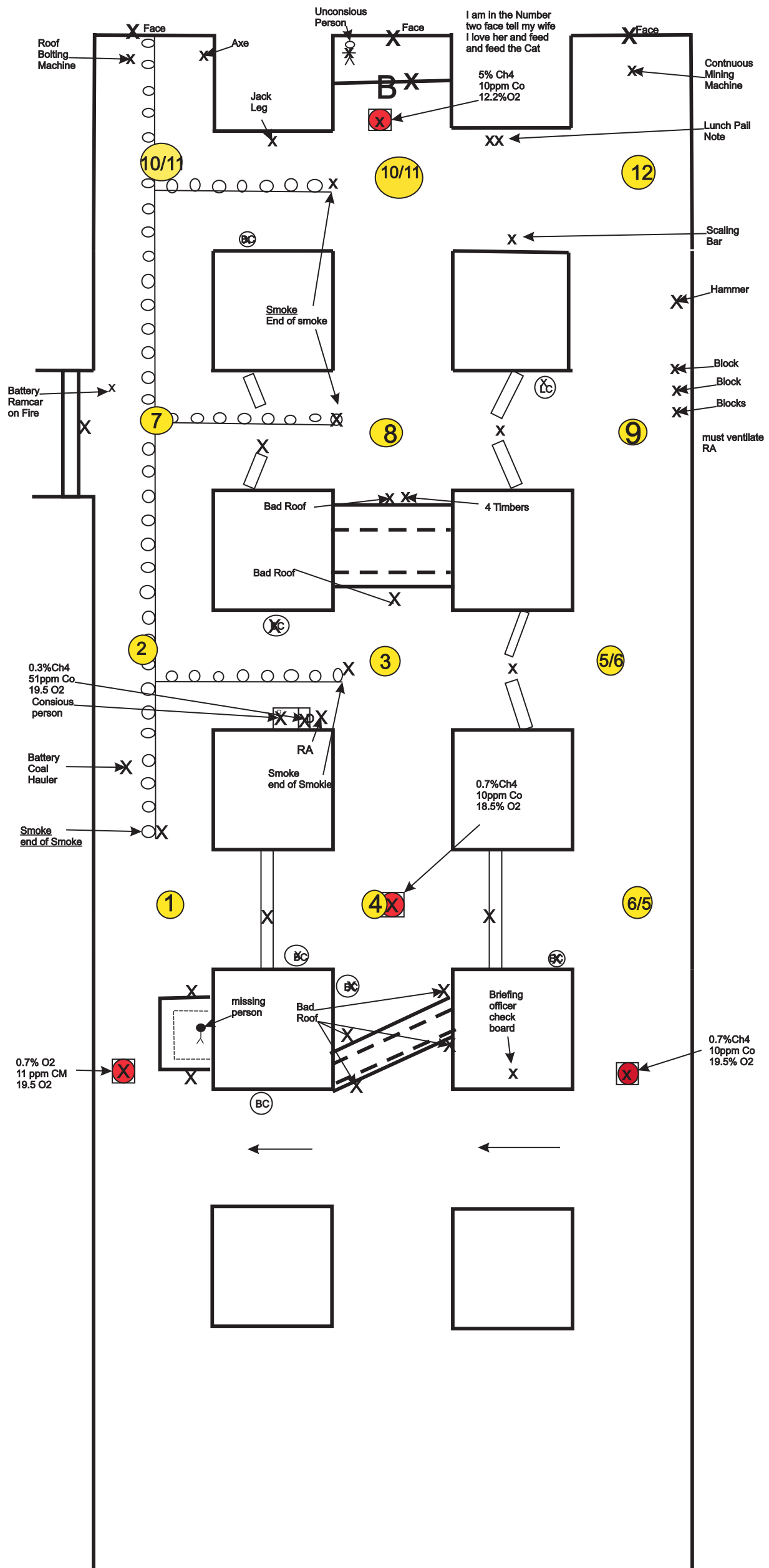

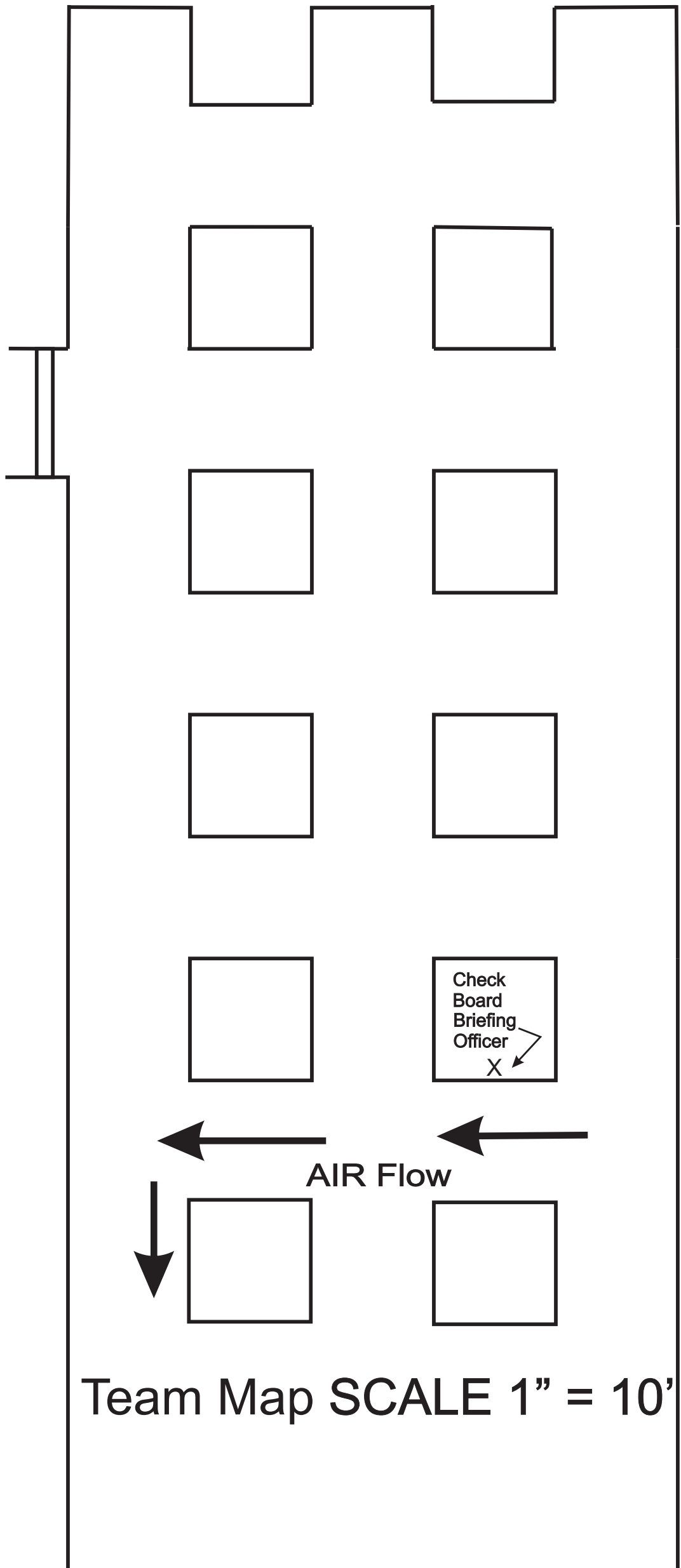

Team Map SCALE 1" = 10'

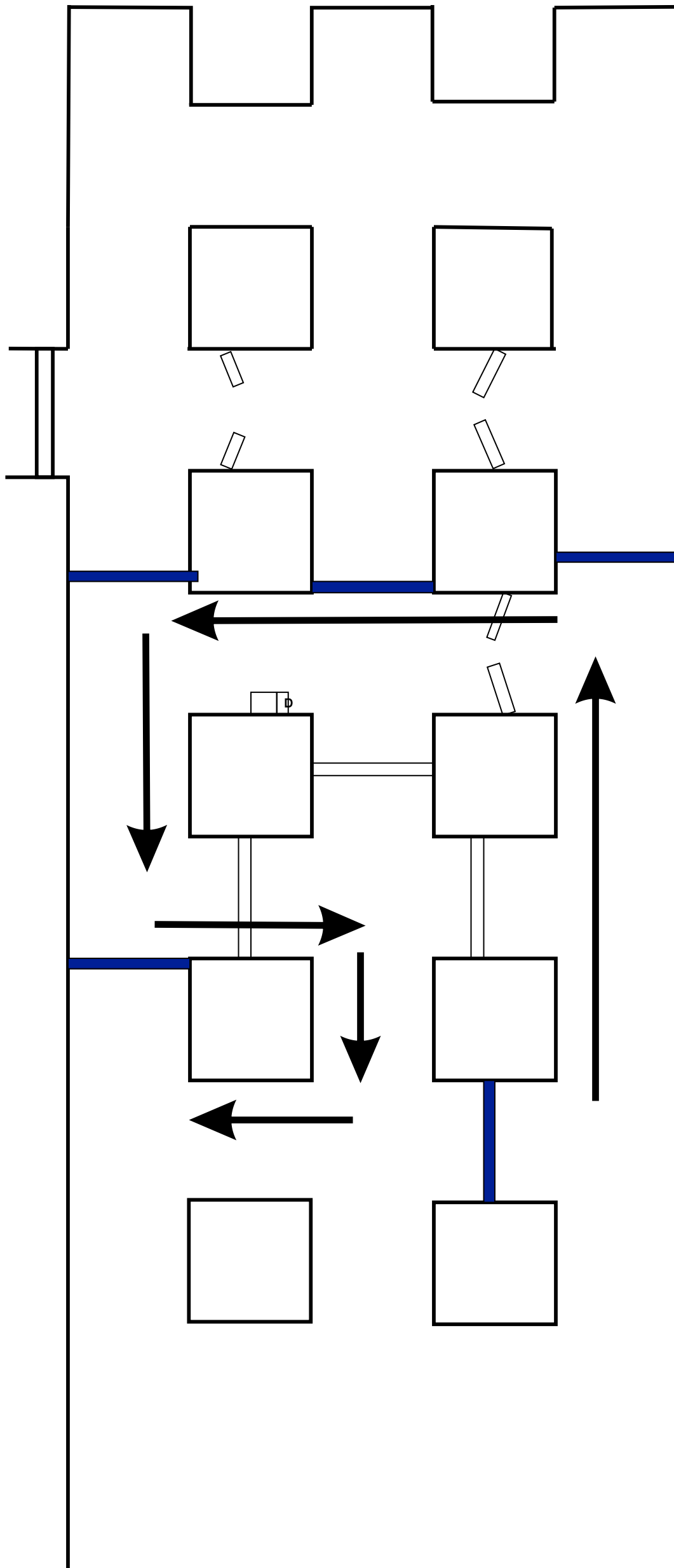

STEP 1 VENTILATION

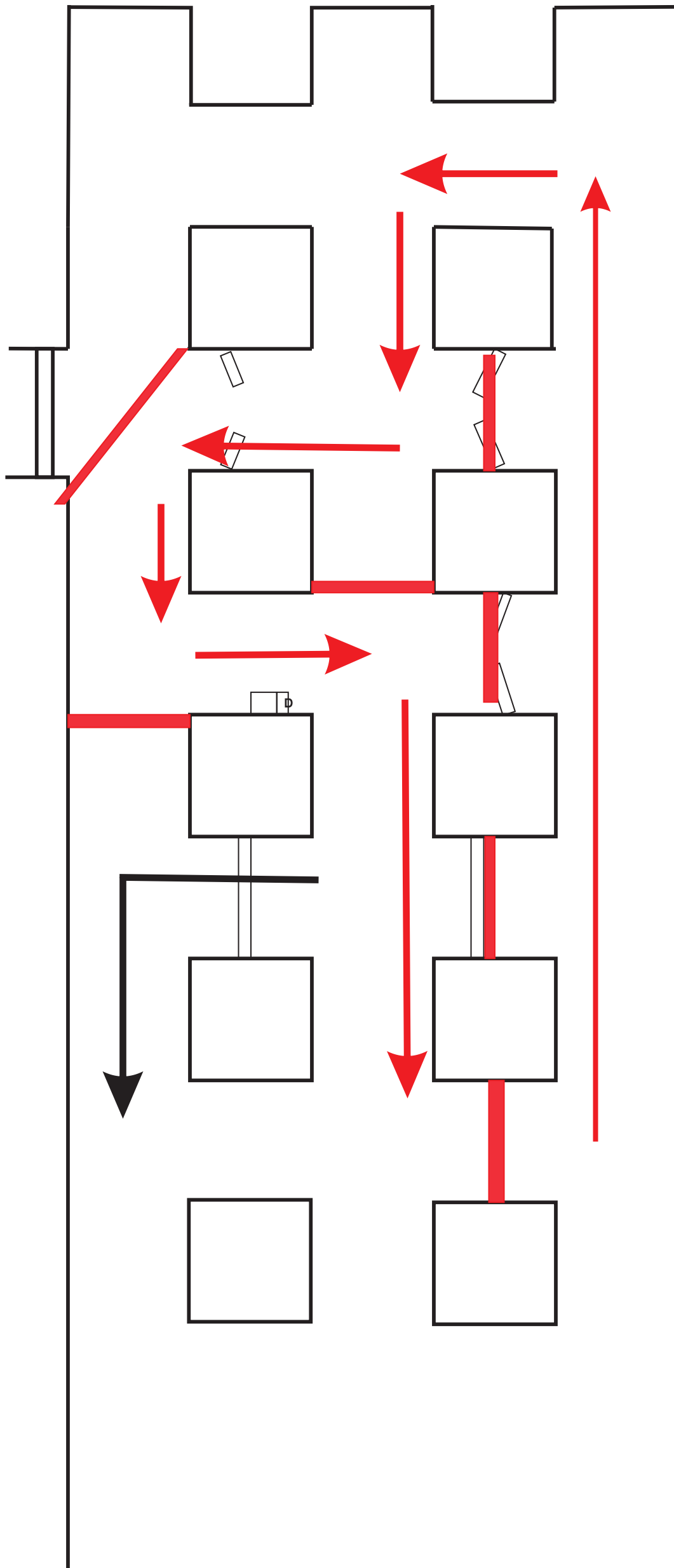

STEP 2 Ventilation

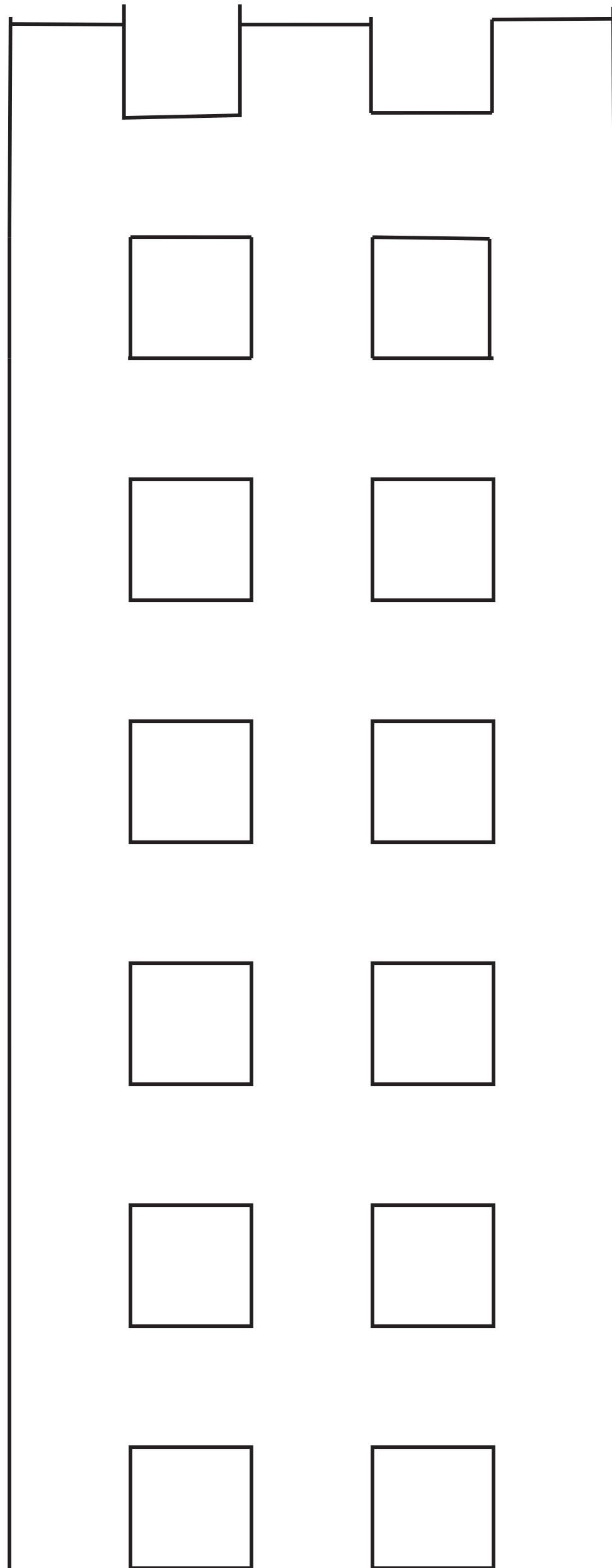

JUDGES BLANK MAP

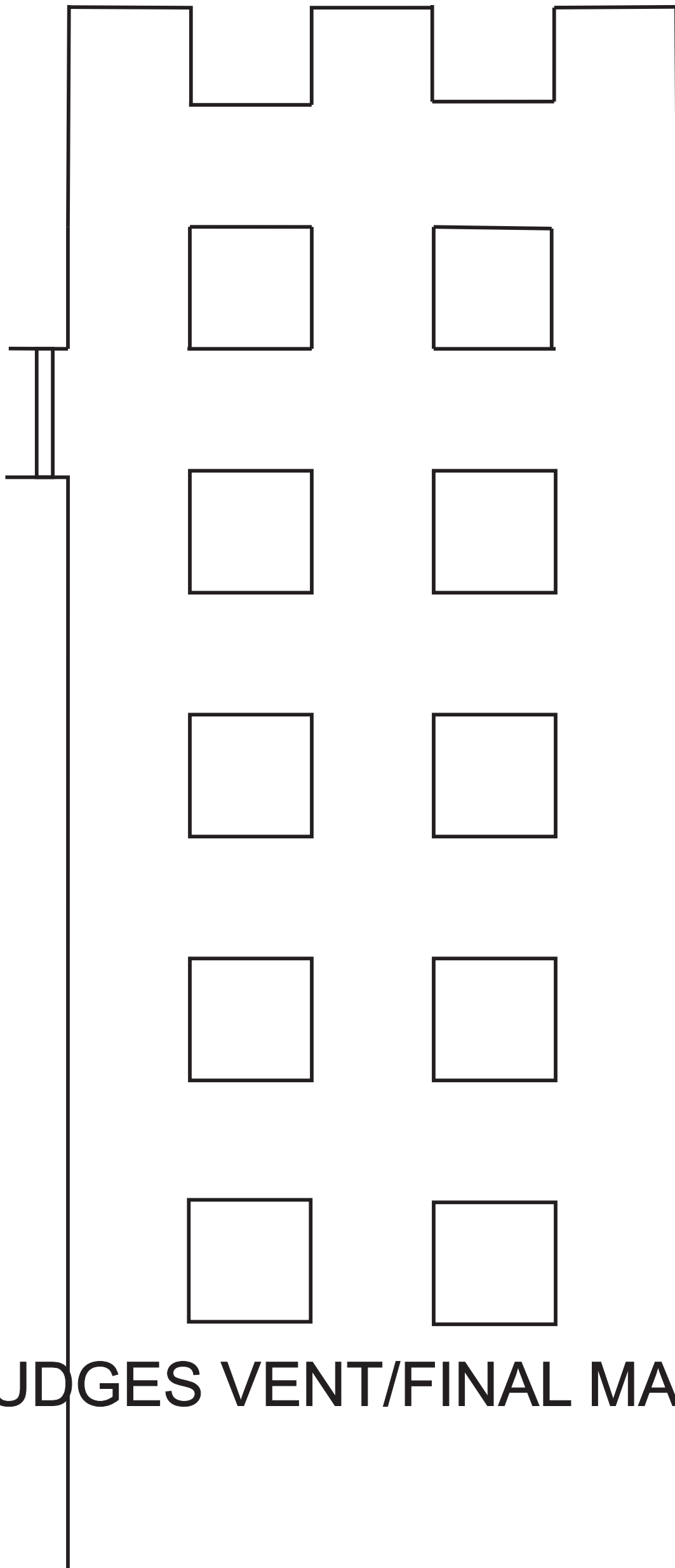

JUDGES VENT/FINAL MAP